

An Efficiency Degradation Model of Power Amplifier and the Impact against Transmission Power Control for Wireless Sensor Networks

Shinji Mikami

Kanazawa University, Kanazawa, Ishikawa 920-1192, Japan

E-mail: mik@cs28.cs.kobe-u.ac.jp

Takashi Takeuchi, Hiroshi Kawaguchi, Chikara Ohta and Masahiko Yoshimoto
Kobe University, Kobe, Hyogo, 657-8501, Japan

Abstract—To extend an available period of wireless sensor networks, transmission power control is regarded as one of the promising schemes. In most of the previous studies on the transmission power control, it is assumed that a transmitter has power consumption of $O(d^n)$, where d and n denote a maximum communication distance and a pass loss factor. This assumption would substantially hold under the condition that the transmission efficiency is always constant at any transmission power (efficiency-fixed model). In practice, however, the transmission efficiency degrades as the transmission power is reduced. We analytically verify that an actual power amplifier with the efficiency degradation has a power consumption of $O(d^r)$, where $n/2.8 \leq r \leq n/2$ (efficiency-degradation model). The efficiency-degradation model gives the negative impact against the transmission power control.

Index Terms—Wireless sensor network, transmission power control, transmission efficiency, pass loss factor.

I. INTRODUCTION

Recent advances in microsensors, integrated circuits and wireless communication technologies enable WSNs (wireless sensor networks) consisting of a number of small nodes to be emerging. One of the most important issues on WSNs are to extend an available period under the condition that each sensor node has only a strict energy budget. For this sake, it is effective to reduce power consumption of an RF (radio frequency) block in a sensor node since it is one of the major power consuming block in the whole ([3], [11]).

Transmission power control enables a transmitting node to reduce the power of the RF block to a small extent enough to communicate with an intended receiver node, which is expected to save the node power. Therefore, many researchers have studied the effect of the transmission power control in analytical manners and/or by means of simulations. Most of these studies assume that a power in a transmitter, p_{TX} , and a transmission distance, d , have a relationship, $p_{TX} = \alpha_{TX} + \rho_{TX} \cdot d^n$, where α_{TX} and ρ_{TX} are constant factors and n ($= 2 \sim 4$) denotes a path loss factor ([1], [2]) This assumption would substantially holds under the condition that the efficiency of the RF block is always constant at any antenna power. In practice, however, the efficiency varies with the antenna power. It turns out worse in lower antenna power in particular.

To the best of our knowledge, the negative influence of the efficiency variation in an RF block has not been well

studied. [7] refers to the efficiency variation, but the above influence on WSNs is not discussed at all. In the paper, the author employs a linear relationship between the radiated power, P_{tx} , and the DC power, P_{dc} , of RF transmitter: $P_{dc} = \epsilon p_{TX} + P^*$, $0 \leq p_{TX} \leq P_{max}$, where ϵ is a constant factor, and P_{max} and P^* denote the maximum power consumption and the total static power consumption, respectively. The author states that this model can be derived from data sheets of existing PAs (Power Amplifiers) and manufactural single-chip transceivers. This linear relationship leads to a simple model for the variation of the efficiency, $\kappa = p_{TX}/P_{dc}$, of an RF block: $\kappa = 1/(\epsilon + P^*/p_{TX})$.

In this paper, we describe the impact against the transmission power control in detail. There are a few ways to control an antenna power. One is to change an output impedance of a transistor in an power amplifier, and another is to vary an amplitude of an RF input. Since the discussion of the latter case is deeply related to an architecture of an transmitter and its peripherals, we remain the latter case in the future and address the former case. So, we model a power amplifier in the final stage of an transmitter as integrated circuits consisting of source impedance, impedance-matching network and antenna impedance. Then, we analyze the model in two ways. First, we introduce the matching theorem to the power amplifier. Second, we extend it to realistic class-A and class-C amplifiers, and compare the analytical results with circuit simulation results.

The first analysis derived from the matching theorem reveals that the power consumption of the power amplifier, p_{PA} , is proportional to $d^{n/2}$. To make matters worse, the second analysis shows that p_{PA} is proportional to $d^{n/2.6}$ in the class-A amplifier and to $d^{n/2.8}$ in the class-C amplifier. In other words, it can be said that p_{PA} is proportional to $d^{n/m}$, where we call m the efficiency-degradation factor and we name this relationship the efficiency-degradation model (ED model). The efficiency-degradation factor theoretically satisfies $m \geq 2$, and the efficiency of the transmission power control becomes worse as m is larger. Consequently, the ED model brings the different results from the conventional expression, d^n (we called this the efficiency-fixed model (EF model) in this paper). For the transmission power control, we suggest that a power consumption in an RF block should be handled with the proposed ED model instead of the conventional EF model.

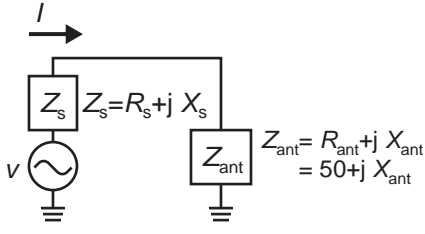

Fig. 1. Matching circuit.

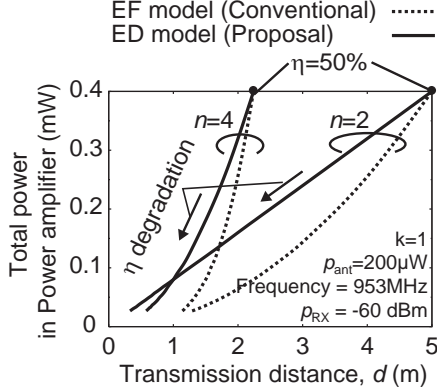

Fig. 2. PA power dependencies on transmission distance in EF and ED models.

II. FUNDAMENTAL STUDY BASED ON MATCHING THEOREM

Figure 1 is a simplified schematic of power amplifier. Z_s is a source impedance, and the antenna generally has a 50-ohm impedance. In this figure, an antenna power, p_{ant} , and source power, p_s , are expressed as follows:

$$p_{ant} = R_{ant}|I|^2 = \frac{R_{ant}|E|^2}{(R_s + R_{ant})^2 + (X_s + X_{ant})^2}, \quad (1)$$

$$p_s = R_s|I|^2 = \frac{R_s|E|^2}{(R_s + R_{ant})^2 + (X_s + X_{ant})^2}.$$

p_{ant} becomes the maximum power (and transmits the maximum power from the antenna) if the impedances are matched. In this case, $R_s = R_{ant}$ and the antenna-power efficiency is 50% according to the matching theorem. The reactances in the equations can be canceled thanks to the impedance matching network, which means that p_{ant} can be controlled by changing the source resistance, R_s . When R_s is set to aR_s ($R_s \rightarrow aR_s, a \geq 1$), (1) turns out to the following:

$$p_{ant} = \frac{R_{ant}|E|^2}{(aR_s + R_{ant})^2} = \frac{1}{(1+a)^2} \frac{|E|^2}{R_{ant}}, \quad (2)$$

$$p_s = \frac{aR_s|E|^2}{(aR_s + R_{ant})^2} = \frac{a}{(1+a)^2} \frac{|E|^2}{R_{ant}}.$$

Note that R_s can not be reduced, which causes efficiency degradation as follows:

$$\eta = \frac{p_{ant}}{p_{PA}} = \frac{p_{ant}}{p_{ant} + p_s} = \frac{1}{1+a}. \quad (3)$$

A propagation loss, L , in free-space is represented as follows:

$$L = \frac{\lambda^2}{(4\pi)^2 d^n}, \quad (4)$$

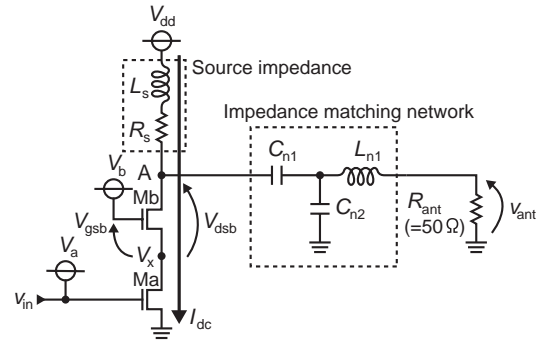

Fig. 3. Cascode power amplifier.

where d is a transmission distance, and n is a path loss factor. Hence, a received power, p_{RX} , in a receiver placed d apart from the transmitter, is give as follows:

$$p_{RX} = k \frac{\lambda^2}{(4\pi)^2 d^n} p_{ant} = k \frac{\lambda^2}{(4\pi)^2 d^n} \frac{R_{ant}}{|E|^2} p_{PA}^2. \quad (5)$$

p_{PA} is eventually as follows:

$$p_{PA} = \sqrt{\frac{(4\pi)^2 |E|^2 p_{RX}}{k \lambda^2 R_{ant}}} d^{n/2}. \quad (6)$$

This equation indicates that a PA power is proportional to the maximum transmission distance, d , to the power of $n/2$ instead of n . Thus the degradation factor satisfies $m = 2$. Figure 2 compares the conventional EF and proposed ED models, obtained by a simulation. The figure shows that the transmission-power control is no use if $n = 2$.

III. EFFICIENCY ANALYSIS IN ACTUAL CIRCUIT

In the previous section, we pointed out that transmission control becomes less effective according to the matching theorem. To make matters worse in an actual circuit, the situation gets more pessimistic.

Figure 3 is called a cascode amplifier that is widely used as a power amplifier. There are two ways to control the transmission power.

- 1) Changing a bias voltage of V_a .
- 2) Changing a bias voltage of V_b .

By changing V_b , the source impedance is varied. Besides, a bias current, I_{dc} , is affected by V_b . When V_a is changed, a firing angle in a transistor Ma is varied. In other words, the operating class is varied. Theoretically, the efficiency of the class C is much better than the class A. However, the antenna power of the class C cannot be enlarged [10]. Thus, the class-A amplifier is widely utilized as a power amplifier.

A. Class-A power amplifier

In this subsection, relationships between the PA power and transmission distance are discussed. The antenna power can be controlled by changing V_b . When $V_b = V_{dd}$, the maximum antenna power can be obtained, while it is reduced to zero when $V_b = 0$. In this manner, the antenna power is controllable, although the efficiency gets worse than the case in

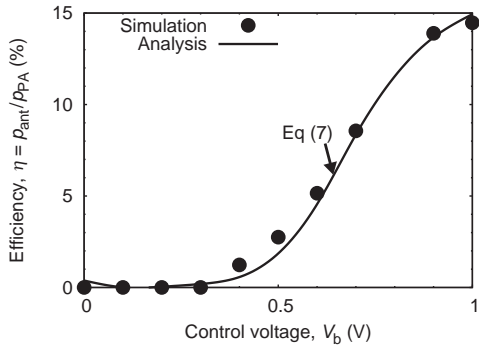

Fig. 4. PA efficiency.

the matching theorem because of the bias current. The power efficiency in the actual circuit is given as follows:

$$\eta = \frac{p_{\text{ant}}}{P_{\text{dc}} + p_{\text{s}} + p_{\text{ant}}}, \quad (7)$$

where P_{dc} is the DC power of power amplifier. This is an additional term caused by the bias (compare with (3)).

The circuit conditions are as follows:

- Circuit simulator; Advanced Design System (ADS) 2004A (Agilent Technologies)
- Transistor parameter; OKI 0.15- μm SOI-CMOS process
- V_{dd} ; 1V
- V_{a} ; 0.6 V
- $|v_{\text{in}}|$ (amplitude of v_{in}); 0.2 V
- Operating frequency; 953MHz
- Quality factor of L_{s} ; 20

The PA power p_{PA} is expressed as follows using a small signal equivalent circuit for AC power and equations referred to [9] for DC power:

$$\begin{aligned} p_{\text{PA}} &= P_{\text{dc}} + p_{\text{s}} + p_{\text{ant}} \\ &= \frac{\beta_{\text{b}}}{2} (V_{\text{b}} - V_{\text{x}} - V_{\text{t}})^{\chi} \left\{ 1 + \lambda(V_{\text{dd}} - V_{\text{x}}) \right\} \\ &\quad + \zeta \cdot g_{\text{ma}}^2 \cdot v_{\text{in}}^2 + \xi \cdot g_{\text{ma}}^2 \cdot v_{\text{in}}^2, \end{aligned} \quad (8)$$

where β_{b} is its gain factor, V_{t} is a threshold voltage of Mb, g_{ma} is a transconductance of Ma, and ζ and ξ are constant.

Figure 4 illustrates the PA efficiency, and it can be seen that the efficiency is degraded as V_{b} is lowered. Figures 5 and 6 show relationships between the PA power and transmission distance that are obtained by (5) and (8). The curves can be fitted to a form of $\rho_{\text{TX}} \cdot d^r$ using the least squares method, in which the parameters, ρ_{TX} and r , are signified in the figures. The results show that the PA power consumption is proportional to the transmission distance to the power of $n/2.6$. The degradation factor, m , is worse than that in the matching-theorem case because the DC power is added to the PA power.

B. Class-C power amplifier

In a Class-C amplifier, a circuit simulation is carried out with Advanced Design System 2004A (Agilent Technologies), from which m is obtained as 2.8. The results are shown in Figs. 7 and 8.

IV. IMPACT OF DEGRADATION OF EFFICIENCY

In this section, we discuss the optimal number, h_{opt} , of hops to minimize the total power, P_{total} , of all nodes in the case where they are evenly spaced on a straight line and the one end node sends packets to the other. References [2], [5] show similar discussions using EF model.

In this paper, we vary the value of the degradation factor m for the ED model. We assume that a transmitter has the same power consumption, $P_{\text{TX,max}}$, with the highest efficiency, for any m and n at the maximum transmission distance d_{max} . As a result, ρ_{TX} is expressed as a function of the value of $r = n/m$ as follows:

$$\rho_{\text{TX}}(r) = \frac{P_{\text{TX,max}} - \alpha_{\text{TX}}}{d_{\text{max}}^r}. \quad (9)$$

Further, we assume that the receiving power, α_{RX} , is a constant.

P_{total} is given by

$$P_{\text{total}} = h \left\{ \alpha_{\text{TX}} + \alpha_{\text{RX}} + \rho_{\text{TX}}(r) \left(\frac{d_{\text{total}}}{h} \right)^r \right\}, \quad (10)$$

where h and d_{total} denote the number of hops and the distance between the end nodes, respectively. Substituting (9) to (10) and performing some algebra lead to the optimal number h_{opt} of hops as follows:

$$h_{\text{opt}} = \begin{cases} \frac{d_{\text{total}}}{d_{\text{max}}} \left(\frac{(1-\nu_{\text{TX}})(r-1)}{\nu_{\text{TX}} + \nu_{\text{RX}}} \right)^{\frac{1}{r}}, & r > \frac{1+\nu_{\text{RX}}}{1-\nu_{\text{TX}}}, \\ \frac{d_{\text{total}}}{d_{\text{max}}}, & r \leq \frac{1+\nu_{\text{RX}}}{1-\nu_{\text{TX}}}, \end{cases} \quad (11)$$

where $\nu_{\text{TX}} = \alpha_{\text{TX}}/P_{\text{TX,max}}$ and $\nu_{\text{RX}} = \alpha_{\text{RX}}/P_{\text{TX,max}}$.

Here, we define the power reduction ratio, R_{rdc} , of total power consumption with the transmission power control in the case of optimal-hop to that in the case where each node transmits at the maximum transmission power. Note that, in the latter case, P_{total} is given as $(P_{\text{TX,max}} + \alpha_{\text{RX}}) d_{\text{total}}/d_{\text{max}}$. Taking this into account and substituting (11) to (10), we have

$$R_{\text{rdc}} = \begin{cases} r \frac{(1-\nu_{\text{TX}})^{\frac{1}{r}}}{1+\nu_{\text{RX}}} \left(\frac{\nu_{\text{TX}} + \nu_{\text{RX}}}{r-1} \right)^{1-\frac{1}{r}}, & r > \frac{1+\nu_{\text{RX}}}{1-\nu_{\text{TX}}}, \\ 1, & r \leq \frac{1+\nu_{\text{RX}}}{1-\nu_{\text{TX}}}. \end{cases} \quad (12)$$

Figures 9 and 10 show the characteristics of R_{rdc} predicted by the EF model ($n = 4$ and $m = 1$) and the ED model ($n = 4$ and $m = 2$), respectively. It is shown in this figure that the EF model estimates the effect of the transmission power control more optimistically than the ED model.

The transmission power control is effective only if $r > (1 + \nu_{\text{RX}})/(1 - \nu_{\text{TX}})$. This is rewritten as

$$\nu_{\text{RX}} < r(1 - \nu_{\text{TX}}) - 1. \quad (13)$$

This expression gives an insight into the relationship among α_{TX} , α_{RX} , $P_{\text{TX,max}}$ and r .

The effective condition is depicted as effective area in Fig. 11. The area shrinks with the value of r , and r reaches 1 so that the effective area disappears. In Fig. 12, the upper boundary lines of the area in the case of $n = 4$ are drawn for the degradation factors $m = 1, 2, 2.6,$ and 2.8 . Therefore, a transceiver should be designed with the receiving power

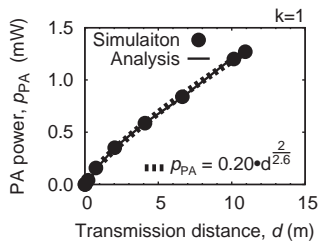

Fig. 5. Characteristics of transmission distance versus power consumption ($n=2$).

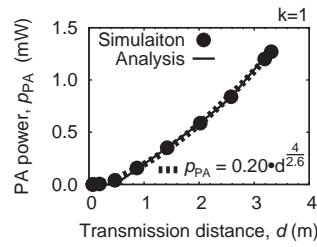

Fig. 6. Characteristics of transmission distance versus power consumption ($n=4$).

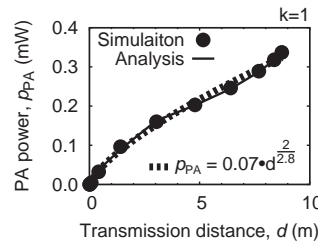

Fig. 7. Characteristics of transmission distance versus power consumption ($n=2$).

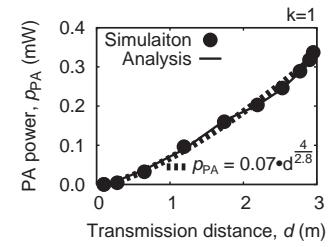

Fig. 8. Characteristics of transmission distance versus power consumption ($n=4$).

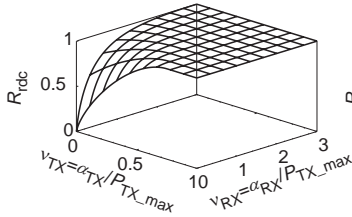

Fig. 9. Characteristics of R_{rdc} ($n=4$, $m=1$).

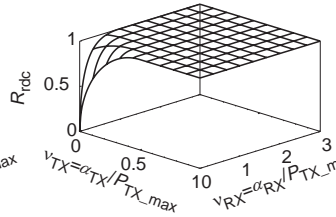

Fig. 10. Characteristics of R_{rdc} ($n=4$, $m=2$).

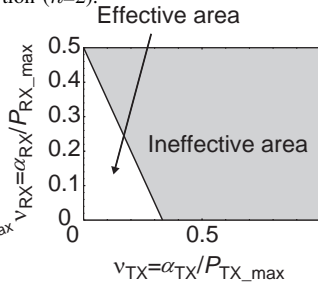

Fig. 11. Emerging effective condition area ($n=3$, $m=2$).

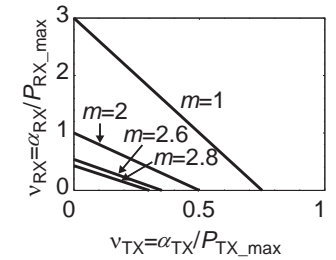

Fig. 12. Impact of degradation of efficiency ($n=4$).

consumption and the constant component of the transmission power consumption small enough to make the transmission power control effective in consideration of the degradation of power efficiency.

As shown in the above, the effectiveness of the transmission power control strongly depends on the degradation of the transmitter efficiency. Therefore, the ED model is more suitable than the EF model for exact studies on the transmission power control.

V. CONCLUSIONS

In most of the previous studies on the transmission power control, it is assumed that the power consumption of a transmitter is modeled as $P_{TX} = \alpha_{TX} + \rho_{TX} \cdot d^n$, called EF model in this paper, where n is the path-loss factor. In this paper, the impact of degradation of transmitter efficiency on transmission power control is investigated by matching theorem and analyses of a realistic circuit with the aid of circuit simulations. As results, we developed the power consumption model named ED model, which makes a transmitter have power consumption $P_{TX} = \alpha_{TX} + \rho_{TX} \cdot d^{n/m}$, where m is the degradation factor. Matching theorem revealed that a transmitter has at least $m = 2$, and the analyses of a realistic circuit showed that the transmitter using A (resp. C) class amplifier has the worse degradation factor $m = 2.6$ (resp. $m = 2.8$). We also showed that the power reduction ratio R_{rdc} by the transmission power control strongly depends on the degradation factor. To conclude, the ED model is more suitable than the EF model for exact studies on the transmission power control.

ACKNOWLEDGMENT

The authors would like to thank Mr. Yukihiro Kita, Mr. Tadashi Chiba, Mr. Koichi Tani, Mr. Tsunaaki Shidei, and Mr. Shunsuke Baba with Oki Electric Industry Co., Ltd. to provide the model and technology file of SOI 0.15 μm . This

research work is supported by the Ministry of Internal Affairs and Communications, Japan, SCOPE, and by the Ministry of Education, Science, Sports and Culture, Japan, Grant-in-Aid for Scientific Research (C), No. 18500052 and for Young Scientists (B), No. 16760271.

REFERENCES

- [1] A. Depedri, A. Zanella, and R. Verdone, "An Energy Efficient Protocol for Wireless Sensor Networks," *Proc. AINS 2003*, Menlo Park, CA, June/July, 2003.
- [2] A. P. Chandrakasan, R. Min, M. Bhardwaj, S. Cho, and A. Wang, "Power Aware Wireless Microsensor Systems," *Keynote Paper. ESSCIRC 2002*, Florence, Italy, 2002.
- [3] E. Shih, S. cho, N. lckes, R. Min, A. Sinha, A. wang and A. Chandrakasan, "Physical layer driven protocol and algorithm design for energy-efficient wireless sensor networks," *Proc. ACM/IEEE MobiCom 2001*, pp. 272-286, July 2001
- [4] J. L.Hill and D. E.Culler, "Mica: A wireless platform for deeply embedded networks," *IEEE Micro*, Vol.22, No.6, pp.12-24, Nov/Dec. 2002.
- [5] J. Rabaey, J. Ammer, Jr. da Silva, and D.J. Patel, "PicoRadio : Ad-hoc Wireless Networking of Ubiquitous LowEnergy Sensor/Monitor Nodes," *Proc. IEEE WVLSI*, Orlando, Florida, April, 2000.
- [6] M. Bhardwaj, T. Garnett, A. P. Chandrakasan, "Upper Bounds on the Lifetime of Sensor Networks," *Proc. IEEE ICC 2005*, pp.785-790, June, 2001.
- [7] M. Haenggi, "The Impact of Power Amplifier Characteristics on Routing in Random Wireless Networks," *Proc. IEEE GLOBECOM 2003*, San Francisco, CA, Dec. 2003.
- [8] M. Haenggi and D. Puccinelli, "Routing in Ad Hoc Networks: A Case for Long Hops," *IEEE Communications Magazine*, Vol. 43, pp. 93-101, Oct. 2005.
- [9] T.Sakurai and A.R.Newton, "Alpha-Power Law MOSFET Model and Its Application to CMOS Inverter Delay and Other Formulas," *IEEE Journal of Solid-State Circuits*, Vol.25, No.2, pp.584-594, Apr. 1990.
- [10] B.Razavi, "RF Microelectronics," Prentice Hall, 1998.
- [11] C.S. Raghavendra, K. M. Sivalingam and T. Znati "Wireless Sensor Networks," Kluwer Academic Publishers, 2004.